



COREMO OCMEA S.P.A.

Via Galilei, 12 - 20090 Assago (MI) - Italy

Tel. +39 024880697 Fax +39 024881940

www.coremo.it info@coremo.it

User and Maintenance Manual



FAILSAFE HYDRAULIC BRAKE ID 2000N-116



ISO 9001 - Certificate N°0238

Translation of the original instructions
EN 140627 REV. 1.2



	User and Maintenance Manual <i>Failsafe hydraulic brake ID 2000N</i>		Model ID 2000N-116
	Date: 2014/06/27	Revision: 1.1	www.coremo.it

TABLE OF CONTENTS

1.	Introduction	3
2.	Manufacturer	3
3.	General information.....	3
4.	Warnings	5
5.	Technical data	6
5.1.	Product performance	6
5.2.	Brake lining wear.....	6
5.3.	Special note.....	6
6.	Transport and storage.....	7
7.	Installation.....	8
8.	Operation	12
8.1.	Power feed of the safety component	12
8.2.	Improper use.....	13
9.	Maintenance and cleaning.....	14
9.1.	Restoring the play	14
9.2.	Replacement of the lining pads and cleaning the friction surfaces.....	15
9.3.	Changing the sealing rings.....	17
9.4.	Changing the cup springs	21
9.5.	Periodic maintenance.....	24
10.	Spare parts list.....	25

	User and Maintenance Manual <i>Failsafe hydraulic brake ID 2000N</i>		Model ID 2000N-116
	Date: 2014/06/27	Revision: 1.1	www.coremo.it

1. Introduction

The purpose of this manual is to provide the user with all the information necessary to use the product properly, independently and as safely as possible.

This manual constitutes an integral part of the safety features and must be read in its entirety before installation and use of the product. It must therefore be kept in a safe place should future reference be necessary before proceeding with any kind of work.

The user is strongly advised to read it carefully and to follow the rules and procedures contained in it as these provide important information concerning safe use and maintenance.

If any doubt should arise concerning the correct interpretation of the instructions, contact our technical department for the necessary clarification.

It is prohibited for anyone to disclose or modify the content of this manual or to use it for personal purposes.

2. Manufacturer

COREMO OCMEA S.P.A.

Via Galilei, 12 - 20090 Assago (MI) - Italy

Tel.: +39 024880697 Fax: +39 024881940

e-mail: info@coremo.it

3. General information

Correct use of the product: In compliance with Italian Legislative Decree 17/2010 and DIRECTIVE 2006/42/EC the operating limits for perfect and safe use of the product are stated in this manual.

Design parameters: COREMO OCMEA brakes have been designed in compliance with the norm UNI EN ISO 12100:2010 and to satisfy the performance requirements and conditions stated in the catalogue and in Chapter 5 of this manual.

Model selection: Selection of the correct model for a given application is of basic importance. In the case of failsafe brakes the service factor must not be less than 2. The technical department of COREMO

	User and Maintenance Manual <i>Failsafe hydraulic brake ID 2000N</i>		Model ID 2000N-116
	Date: 2014/06/27	Revision: 1.1	www.coremo.it

OCMEA can provide you with information, suggestions and assistance regarding correct application and use.

Use: Following the mounting and maintenance instructions prevents costly down time and accidents due to incomplete knowledge of the product. Please note that the initial braking force may be from 30% to 50% less than the rated value until the brake lining adjusts to the disc.

Rotating parts: The brakes are coupled mainly with rotating parts. In this case the moving parts must be protected in conformity with the requirements of DIRECTIVE 2006/42/EC and Italian Legislative Decree 17/2010 or equivalent legislation in force in the countries in which they are used.

Power source for hydraulic brakes: Use mineral oil SAE/ISO 46.

Spring loaded failsafe brakes: Spring loaded failsafe brakes must be handled with special care because they contain mechanically preloaded springs. In order to avoid the risk of accidents during maintenance work, it is necessary to follow the instructions in this manual.

Friction material: All COREMO OCMEA brakes are fitted with friction material which is absolutely free of asbestos and is declared as NON toxic/harmful in full observance of health and environment regulations and laws. In any case it is better not to inhale dust produced by them and to wash hands thoroughly before eating or drinking.

Oils, greases, lubricating components: These are used in extremely limited quantities. Personnel suffering from allergies to these substances are advised to wear gloves or use protective cream which must be washed off thoroughly before eating or drinking.

Cleaning of the product: Do not wash the product with water or any detergent.

Product markings: All the data on the plates must always be kept legible. Use the data shown on the plates when contacting the manufacturer for spare parts, information or assistance for example.

Disposal: Worn brake linings and other materials of which brakes are made are classified as special NON toxic/harmful products and therefore must be disposed of in accordance with the laws in force in the countries in which they are used.

	User and Maintenance Manual <i>Failsafe hydraulic brake ID 2000N</i>		Model ID 2000N-116
	Date: 2014/06/27	Revision: 1.1	www.coremo.it

4. Warnings



Failure to follow the instructions in this manual and on any plates attached to the product exposes persons to risks and may cause damage to the equipment and machinery.

- The product must not be used at an ambient temperature lower than -20 °C.
- The disc must be made of iron alloy (cast iron or steel) having a hardness in the range 190 to 220 HB.

The technical department of COREMO OCMEA can provide additional information in order to ensure correct application and use of the product.

Dangers caused by a power failure: A power failure will cause the brake to be applied suddenly. It is therefore necessary to provide an uninterrupted power supply or, if the case requires, use suitable power failure warning systems as a brake failure may cause personal injury and damage to property.

Danger of breakage during operation: To reduce the risk of breakage during operation carry out the periodic inspections shown in this manual.

Risks connected with changes in operating conditions: The products are designed for the purposes stated in this user and maintenance manual therefore the minimum power supply pressure is indicated to ensure that the brake can be opened and the maximum pressure to ensure that braking is always safe and reliable. The operating conditions also vary depending on the diameter of the brake disc used; an equation for calculating the dynamic torque as a function of disc diameter is given in this manual. It should be stressed that an error in calculation will result in a braking torque that is different from the desired value and this may represent a risk to safety.

Residual risk: Residual risk can be attributed to the operator not following all the procedures stated in the user and maintenance manual and not giving due consideration to the warnings.

	User and Maintenance Manual Failsafe hydraulic brake ID 2000N		Model ID 2000N-116
	Date: 2014/06/27	Revision: 1.1	www.coremo.it

5. Technical data

5.1. Product performance

The type "ID 2000N-116" failsafe hydraulic brake has a tangential force of 116000 N attributing a coefficient of friction of 0.4

Warning: The value of the friction coefficient is purely theoretical as it depends on environmental conditions and on how the product is used.

The hydraulic failsafe brake is intended exclusively for emergency stops or holding stops.



Use of the product for any purpose other than those indicated may represent a risk to any aspect of safety.

▪ Dynamic torque

The dynamic torque provided by the brake will be a function of the diameter of the disc used and can be determined using the following equation:

$$\text{Dynamic torque [Nm]} = \text{tangential force [N]} \times (\text{radius of the disc [m]} - 0.071)$$



An error in calculation will result in a braking torque different to the desired value and a risk to aspects of safety.

The technical department of COREMO OCMEA can provide information, suggestions and assistance for correct application and use of the product.

5.2. Brake lining wear



The thickness of each single new lining is 15 mm. A maximum overall lining wear of 18 mm is allowed. Failure to remain within the above limit may represent a risk to aspects of safety.

5.3. Special note

During braking kinetic energy is converted into heat caused by friction between the surfaces of the brake linings and the brake disc. It is therefore fundamentally important to consider the amount of heat that can be dissipated.

	User and Maintenance Manual <i>Failsafe hydraulic brake ID 2000N</i>		Model ID 2000N-116
	Date: 2014/06/27	Revision: 1.1	www.coremo.it



Ignoring the heat produced during braking affects brake lining wear and may jeopardize the safety of the operators and the reliability of the product. Since a brake can be used for many applications it is advisable to contact the technical department of COREMO OCMEA for further explanation in this regard.

6. Transport and storage



Personnel assigned to this work must wear suitable PPE such as gloves, safety footwear and take any other precautions necessary before proceeding with transport, handling and storage of the this part.

1. **Transport:** When handling it is important to bear in mind the dimensions and weight of each type of product as shown in the product drawing enclosed with this manual and in the catalogue of the brake type in question.
2. **Storage:** When storing brakes it is important to bear in mind that a considerable weight is concentrated in a small space. Personnel assigned to this work must wear suitable PPE (safety footwear, gloves, etc.) in order to avoid the risk of injury.

7. Installation



THE BRAKE MUST BE INSTALLED WITH THE MACHINE OFF.

Personnel assigned to this work must wear suitable PPE such as gloves, safety footwear and take any other appropriate precautions to ensure adequate protection and avoid the risk of injury.

1. The ID 2000N-116 brake must be installed on a bracket having the same thickness as the disc minus 2 mm (Figure 1).
 The brake must be anchored using three M30 class 12.9 screws and tightening torque of 2300 Nm.

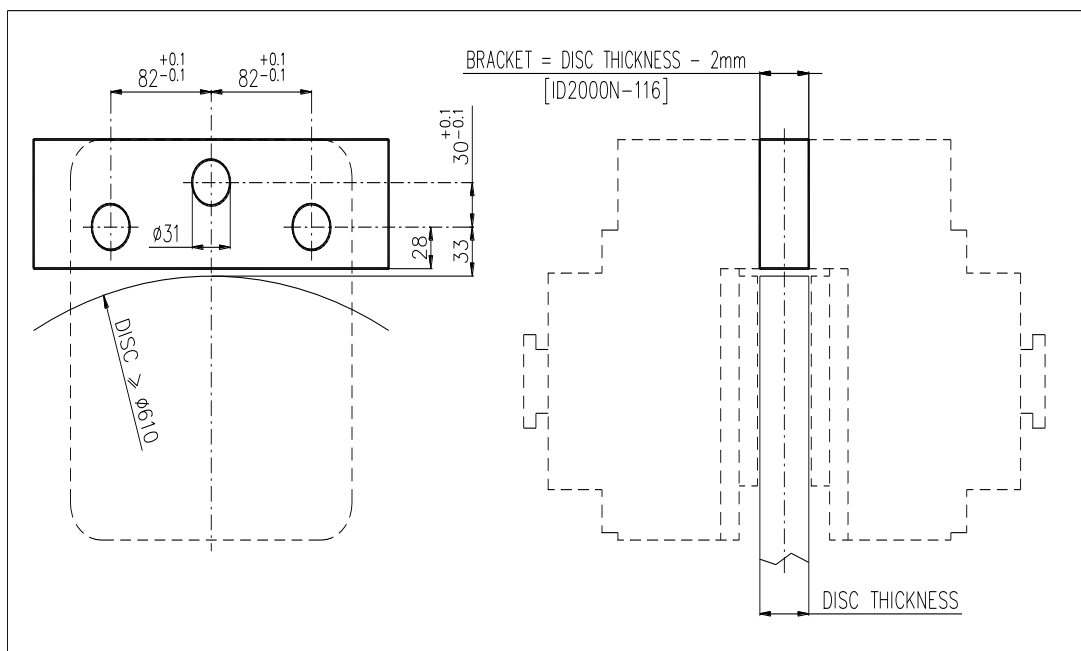

Figure 1

- The fixed part which is to support the brake must withstand a tangential force of 126700 N
2. Connect the brake to the power line using a 1/4" gas fitting. The brake can be supplied on request complete with Ø8 pipe fitting (H0045) already connected.
 3. Pay attention to the control pressure; the pressure not exceed 220 or drop below 200 bar. The brake must be powered exclusively using mineral oil hydraulic fluid.



Do not apply the brake without the disc positioned between the brake linings (Photo 1); failure to follow this rule could result in fingers being crushed and other dangers in addition to damage to the brake itself.

	User and Maintenance Manual <i>Failsafe hydraulic brake ID 2000N</i>		Model ID 2000N-116
	Date: 2014/06/27	Revision: 1.1	www.coremo.it



Photo 1

4. Supply the brake and remove the safety hook (C62257) from the seat of the thruster which protrudes from the cover (Photo 2). To prevent the safety hook from getting lost while the brake is in operation, attach it to the side part of the caliper block (Photo 3) using the TCEI M5x18 screw (C61372) as shown in assembly drawing A..... (use a CH BR 4).



Photo 2



Photo 3

5. The brake is supplied with a bleed vent cod. Z50315 (Figure 2) as in Photo 4. To bleed air out of the circuit, loosen the retaining nut of the fitting (Photo 5) and pull the tubular cap outward. After bleeding off the air tighten the fitting again.

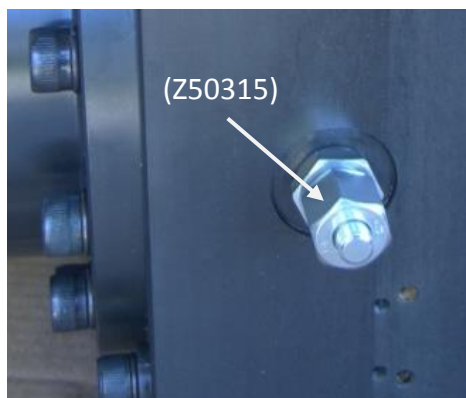

Photo 4



Photo 5

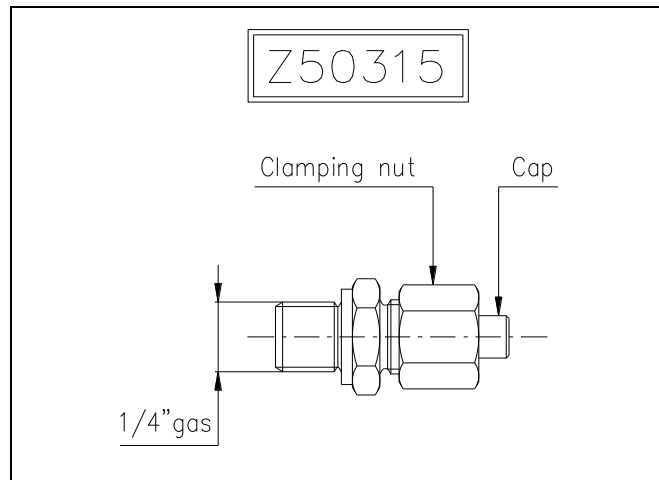

Figure 2



Personnel assigned to these operations must take special care, working cautiously when bleeding the circuit, wearing suitable PPE such as gloves, goggles and safety footwear and taking any other precautions necessary before proceeding.

6. Rotate the play adjuster (D71244) in the clockwise direction using a CH BR 12 (Photo 6) until the play between the disc and each lining is 1 mm (Photo 7).
 Check the gap between the disc and each lining using a feeler gauge.

Pay particular attention during this regulation because rotating the gap regulator (D71244) anticlockwise, this could tighten inside the thruster (D71243) and get definitely stuck.



Photo 6

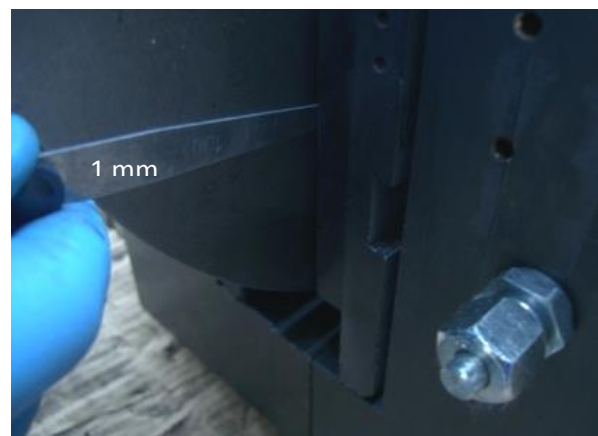



Photo 7

7. Safety lock of the wear adjuster: to prevent the wear adjuster from rotating or moving while the brake is in operation due to machine vibration, each brake unit (K9.....) has two safety grub screws (C61579) to lock the adjuster (D71244), located in the part of the thruster which protrudes from the cover (seat of the safety hook); see also the assembly drawing (A.....) to

	User and Maintenance Manual <i>Failsafe hydraulic brake ID 2000N</i>		Model ID 2000N-116
	Date: 2014/06/27	Revision: 1.1	www.coremo.it

find the positions of the grub screws. To lock and/or unlock the adjuster, tighten and/or loosen the grub screws using a CH BR 3 (Photo 8); when doing this, with the brake in operation or during maintenance, the safety hook (C62257) must not be inserted in the seat of the thruster (D71243) otherwise the operation cannot be carried out.

Warning: The brake is supplied with the wear adjuster NOT locked.



Photo 8

8. **BEDDING-IN:** The initial braking torque may vary from 30% to 50% less than the rated value until the lining has bedded into the disc.
 - a. Before starting the bedding-in, ensure that the lining and disc surfaces are dry and clean.
 - b. Slide the linings on the disc until the disc surface corresponds 100% to that of the linings.
 - c. The disc temperature during bedding -in must not be higher than 100°C.
 - d. Clean the disc and lining surfaces so that there is no trace of dust or dirt.
 - e. After bedding-in check that the disc has no trace of burns.

	User and Maintenance Manual <i>Failsafe hydraulic brake ID 2000N</i>		Model ID 2000N-116
	Date: 2014/06/27	Revision: 1.1	www.coremo.it

8. Operation

8.1. Power feed of the safety component

The control pressure of the hydraulic brake must not exceed 220 bar, while the minimum opening pressure must not drop below 200 bar as already explained in the preceding section. The brake must also be powered exclusively using mineral oil hydraulic fluid.



In case the minimum opening pressure of the brake results lower than the one indicated, stop immediately the machine and change the cup springs. This check is necessary to avoid compromising any safety aspect.

The technical department of COREMO OCMEA can provide information, suggestions and assistance for correct application and use of the product.

To check the minimum opening pressure it is possible to use a hydraulic hand pump by performing the following step:

1. Connect the brake to a manual hydraulic pump (Photo 9)
2. Power up the brake with the hand pump (Photo 10)

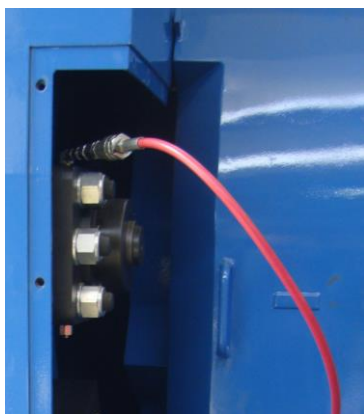

Photo 9



Photo 10

3. Check that the pressure indicated by the manometer of the pump (photo 11) at the opening of the brake is the same as the one previously indicated

	User and Maintenance Manual <i>Failsafe hydraulic brake ID 2000N</i>		Model ID 2000N-116
	Date: 2014/06/27	Revision: 1.1	www.coremo.it



Photo 11

4. In case the minimum opening pressure of the brake results lower than the one indicated, stop immediately the machine and change the cup springs.

8.2. Improper use

The products considered here must be used exclusively as described in chapter 5 of this manual. Any other use is to be considered improper. The manufacturer declines all responsibility for damage caused by improper or unreasonable use of the product.



Use of the product for purposes other than those stated in this manual may compromise any aspect of safety.

	User and Maintenance Manual <i>Failsafe hydraulic brake ID 2000N</i>		Model ID 2000N-116
	Date: 2014/06/27	Revision: 1.1	www.coremo.it

9. Maintenance and cleaning



ALL TYPES OF WORK ON THE BRAKE MUST BE DONE WITH THE MACHINE OFF.

Staff assigned to this work must wear suitable PPE such as gloves and safety footwear and take any further precautions necessary to ensure adequate protection and prevent injury. Failure to follow the instructions given for maintenance and cleaning of the product may compromise personal safety and cause damage to equipment and machinery.



High temperatures may be produced after braking on the surfaces of the disc brake and the brake linings. Personnel must therefore wait for parts subject to overheating to cool down and wear suitable protective gloves and PPE.

9.1. Restoring the play

1. With the brake powered up, loosen two safety grub screws (C61579) to unlock the wear adjuster (D71244) (Photo 12). Rotate the play adjuster (D71244) in the clockwise direction using a CH BR 12 (Photo 12) until the optimally play of 1 mm between the disc and each lining has been restored.



Photo 12

Pay particular attention during this regulation because rotating the gap regulator (D71244) anticlockwise, this could tighten inside the thruster (D71243) and get definitely stuck.

2. Using a feeler gauge, check that the play between the disc and each brake lining is 1 mm (Photo 13).

	User and Maintenance Manual <i>Failsafe hydraulic brake ID 2000N</i>		Model ID 2000N-116
	Date: 2014/06/27	Revision: 1.1	www.coremo.it

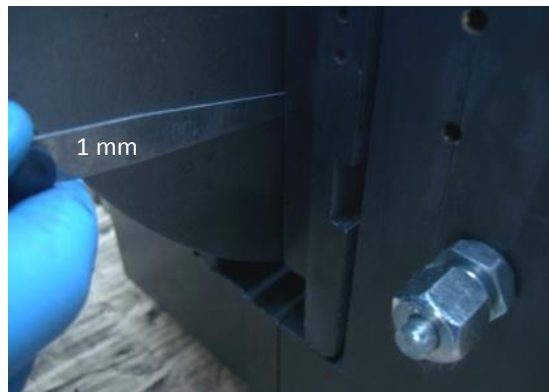

Photo 13

3. Following this operation, retighten the two safety grub screws (C61579) in order to prevent possible rotations and movements of the wear adjuster (D71244) during operation of the brake (Photo 14).



Photo 14

Pay particular attention during this regulation because rotating the gap regulator (D71244) anticlockwise, this could tighten inside the thruster (D71243) and get definitely stuck.

9.2. Replacement of the lining pads and cleaning the friction surfaces

1. Power up the brake and insert the safety hook (C62257) in its seat of the thruster which protrudes from the cover (Photo 15). Once the hook has been inserted the pressure can be removed from the brake. ***(Remove the brake from the machine only if necessary; in this case proceed as described from point 1 to point 3 of section 9.3)***

	User and Maintenance Manual <i>Failsafe hydraulic brake ID 2000N</i>		Model ID 2000N-116
	Date: 2014/06/27	Revision: 1.1	www.coremo.it



Photo 15

2. Loosen the screws (C61397) which anchor the plates (C62242) to the brake (Photo 16) and extract the brake lining guide pins (C62255), without removing the other screws (C61397) which connect the plates to the pins (Photo 17).



Photo 16



Photo 17

3. Pull out the lining pads sideways (Z50330, Z50380 o Z50352) as in Photo 18 until they detach from the magnets (C62344) incorporated in the play adjuster (D71244) (Photo19).



Photo 18



Photo 19

	User and Maintenance Manual Failsafe hydraulic brake ID 2000N		Model ID 2000N-116
	Date: 2014/06/27	Revision: 1.1	www.coremo.it

4. Remove any oil or grease from the surface of the disc using a non-pollutant detergent product.
5. If the brake linings are contaminated only on the surface it is a good idea to clean them using fine emery cloth. If they are contaminated in depth or worn to the limit replace them with new linings.
6. Put the brake linings back following the reverse sequence as described in points 3 and 2.
7. Power up the brake and remove the safety hook (C62257). ***(If the brake has been removed from the machine proceed as described from point 19 to point 21 of section 9.3)***

9.3. Changing the sealing rings

1. Power up the brake and insert the safety hook (C62257) in its seat of the thruster which protrudes from the cover (Photo 20).



Photo 20

2. Cut off the control pressure and disconnect the power line.
3. Remove the brake from the machine.
4. Reconnect the power line and power up the brake.
5. Remove the safety hook (C62257) (Photo 21).



Foto 21

6. Cut off the control pressure and disconnect the power line.
7. Remove the lining pads as described in points 2 and 3 of section 9.2.
8. Unscrew the anchoring screws (C61421) (Photo 22), remove the cover (D71242) (Photo 23) and the cup springs (C62410) (Photo 24).



Take special care during these operations as the brake contains preloaded springs, proceed therefore gradually with the utmost care and attention so that they are completely released and do not jeopardize any aspects of safety.



Photo 22

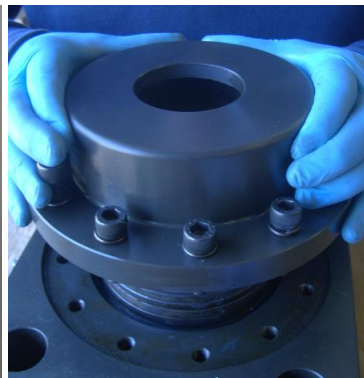

Photo 23



Photo 24

9. Remove also one shim C62256 for the ID 2000N-58 brake and two shims C62256 + one shim C62295 for the ID 2000N-116 brake (Photo 25).
10. Remove the play adjuster (D71244) from the thruster (Photo 26).



Photo 25



Photo 26

11. Carefully remove the thruster (D71243) from the brake body (E80834) carefully allowing compressed air to enter from the feed hole (Photo 27) until the thruster has come out completely (Photo 28).



Photo 27

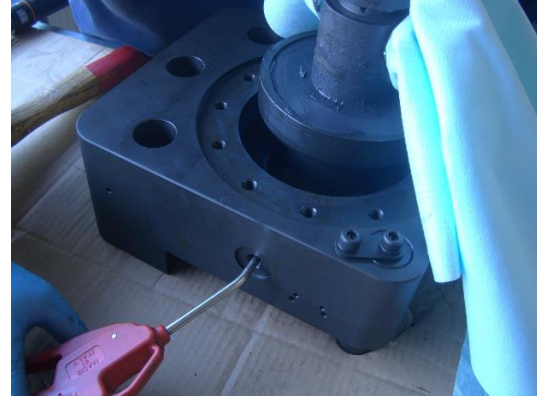

Photo 28

12. Remove the damaged gaskets (Photos 29 and 30) and guide rings (Photo 31) and replace them. It is advisable to replace all the gaskets and all guide rings to avoid further down time. COREMO OCMEA provides a complete kit with 4 gaskets and 2 guide rings.

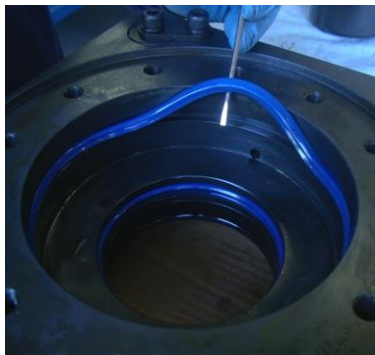

Photo 29

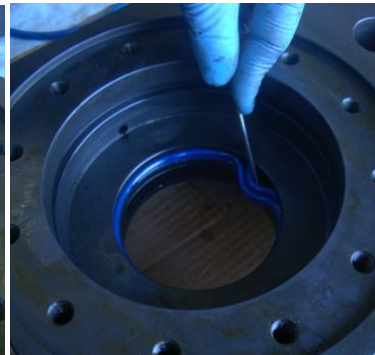

Photo 30

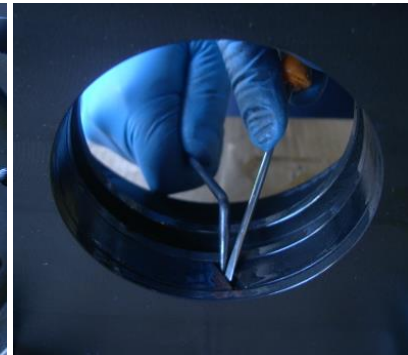

Photo 31

13. Put the play adjuster (D71244) in the thruster (D71243) (Photo 32) then insert this assembly back in the brake body (E80834) (Photo 33).



Photo 32



Photo 33

	User and Maintenance Manual <i>Failsafe hydraulic brake ID 2000N</i>		Model ID 2000N-116
	Date: 2014/06/27	Revision: 1.1	www.coremo.it

14. Put back the cup springs (Photo 34).



Photo 34

15. Put back the cover (D71242) on the brake body (E80834) using the screws (C61421) and washers (C61321) (Photo 35). Tighten the M10 class 12.9 (C61452) screws in a diagonal sequence with a tightening torque of 79 Nm (Photo 36).



Photo 35

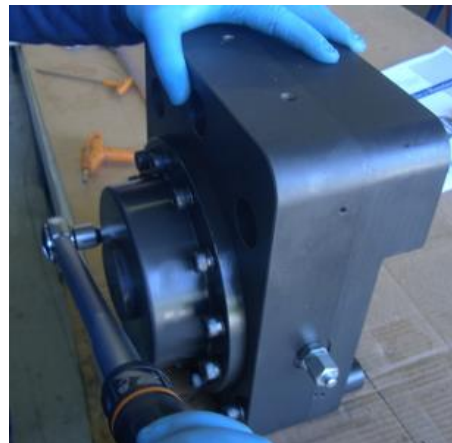



Photo 36

16. Put back the lining pads following the reverse sequence of the procedure described in points 3 and 2 of section 9.2.
17. Connect the power line, power up the brake and insert the safety hook (C62257) in its seat on the thruster which protrudes from the cover.
18. Cut off the control pressure and disconnect the power feed line.
19. Reinstall the brake on the machine.
20. Reconnect the power feed line and power up the brake.
21. Remove the safety hook (C62257) and bleed air from the circuit as described in point 5 of section 7.

	User and Maintenance Manual <i>Failsafe hydraulic brake ID 2000N</i>		Model ID 2000N-116
	Date: 2014/06/27	Revision: 1.1	www.coremo.it

9.4. Changing the cup springs

1. Remove the springs as described from point 1 to point 6 in section 9.3.
2. Unscrew the anchoring screws (C61421) cautiously proceeding in a diagonal sequence and then remove the cover (D71242) (Photo 37).

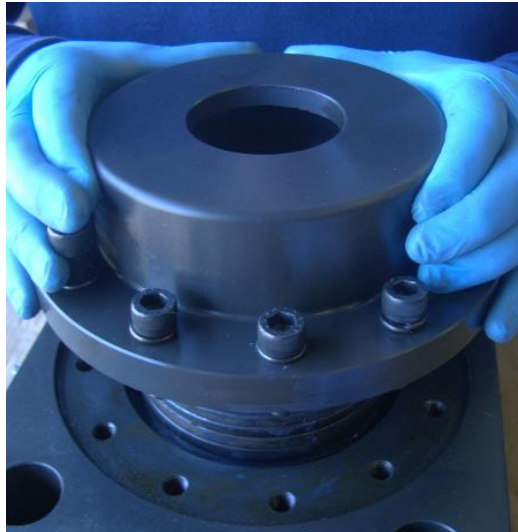

Photo 37



Take special care during these operations as the brake contains preloaded springs, proceed therefore gradually with the utmost care and attention so that they are completely released and do not jeopardize any aspects of safety.

3. Remove, in the following order: 1 shim C62256, 6 cup springs C62410, 1 shim C62256, 1 shim C62295. Replace all the cup springs including those which seem to be in good condition (replace the shims only if necessary).
4. Clean any excess grease from the bottom of the cover and the thruster (Photo 38).



Photo 38

- Lubricate the cup springs (Photo 39) and the part of the thruster in which they are housed with copper paste MOLYguard COMPOUND RA/40 (or similar) (Photo 40), before proceeding with reassembly.



Photo 39

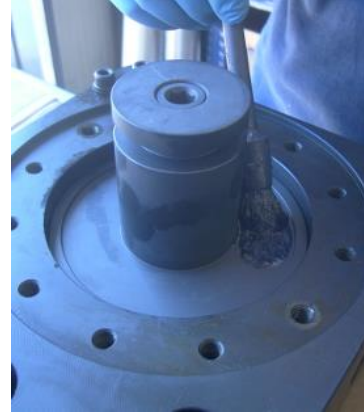

Photo 40

- Insert in the thruster (D71243) the following parts in the following order: 1 shim C62295, 1 shim C62256, 6 cup springs C62410, 1 shim C62256 (Photo 41).



Photo 41



Position the cup springs correctly so that they do not affect the good operation of the brake (Figure 3). Incorrect assembly will result in a tangential force different to what is stated in this manual; the braking torque provided by the safety component will consequently be different to what is desired and to the detriment of safety aspects.

- Put back the cover (D71242) on the brake body (E80834) using the screws (C61421) complete with washers (C61321) (Photo 42). Tighten the M10 class 12.9 screws (C61452) in a diagonal sequence with tightening torque 79 Nm (Photo 43).



Photo 42

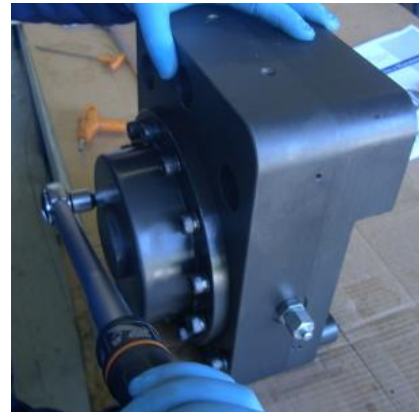

Photo 43

8. Connect the power line, power up the brake and insert the safety hook (C62257) in its seat in the thruster which protrudes from the cover.
9. Cut off the control pressure and disconnect the power line.
10. Reinstall the brake on the machine.
11. Reconnect the power line and power up the brake.
12. Remove the safety hook (C62257) and bleed air from the circuit as described in point 5 of section 7.

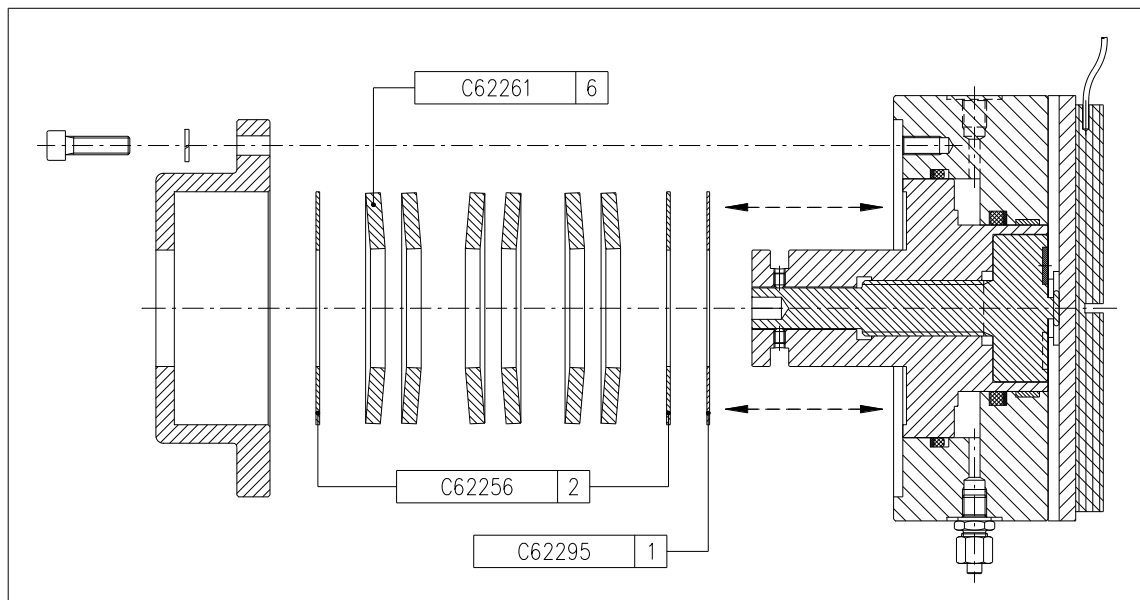



Figure 3 - Position of the cup springs

	User and Maintenance Manual <i>Failsafe hydraulic brake ID 2000N</i>		Model ID 2000N-116
	Date: 2014/06/27	Revision: 1.1	www.coremo.it

9.5. Periodic maintenance



All inspections must be done with the machine switched off.

Although the intervals between these inspections depend on the frequency of use of the brake, they should be done every 3 months in any case so as not to compromise all aspects of safety.

- Using a feeler gauge, check that the play between the disc and each brake lining is 1 mm (Photo 44). If the play encountered is greater, reset the original play as described in section 9.1.

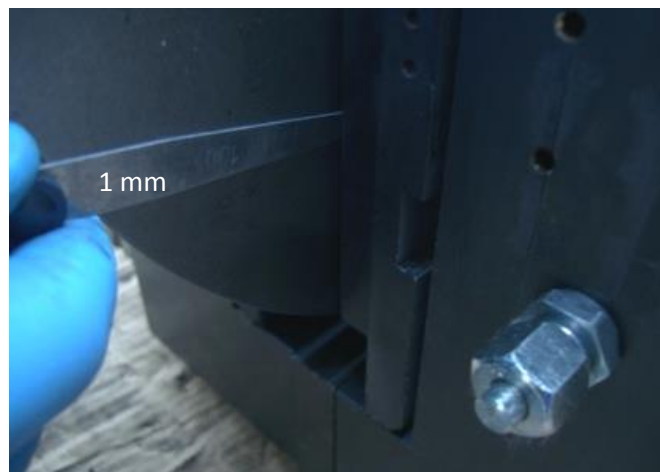



Photo 44

- There is a wear line on the brake lining, however, it is advisable to check that the wear of each lining does not exceed 9 mm in order not to compromise the correct operation and good working condition of the brake. When the lining pads reach maximum wear replace them as described in section 9.2.
- Check that the surfaces of the brake linings and the disc are not contaminated with grease, oil or similar substances which prevent the brake from working efficiently.
- Check that the cup springs are lubricated well.
- Check that the anchor screws of the brake have been tightened correctly.
- Check that the hoses are undamaged.
- Apply the brake repeatedly to check that the gaskets are undamaged and the springs are working correctly.

	User and Maintenance Manual <i>Failsafe hydraulic brake ID 2000N</i>		Model ID 2000N-116
	Date: 2014/06/27	Revision: 1.1	www.coremo.it

10. Spare parts list

In order to avoid costly down time we suggest keeping a stock of the spare parts listed below adequate for the number of brakes in use (the quantities indicate are for each brake):

Lining pads:	Qty. 2 [ST11.2]	cod. Z50330
	Qty. 2 [ST11.4]	cod. Z50380
	Qty. 2 [ST12.2]	cod. Z50352
Cup springs:	Qty. 12	cod. C62410
Shims:	Qty. 4 size 2 mm	cod. C62256
	Qty. 2 size 1.5 mm	cod. C62295
Sealing ring kit:	Qty. 2 gaskets	cod. C62258
	Qty. 2 gaskets	cod. C62259
	Qty. 2 guide rings	cod. C62260

These spare parts must be kept if possible in a dark cool place and away from substances that could damage their capacity to work properly.